

Booth Specifications

Please review the following to ensure that your display meets the Booth Specifications. If your booth does not meet these specifications, you must submit a rendering with dimensions of your display to Show Management for review. All booths, regardless of size, are required to follow these guidelines.

To avoid additional costs (i.e. design cost or tear down of an unapproved structure) please obtain written approval before beginning production or construction of display. For questions or display review, please email tiffany.roe@informa.com.

Booth Configurations

Booth Equipment: Standard 10' x 10' In-Line Booths will be set with 8' high back drape and 3' high side drape. All booths must have some form of professional flooring (carpet, hardwood, etc.). No bare concrete.

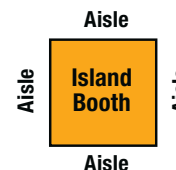
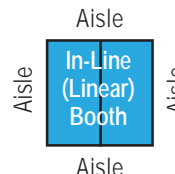
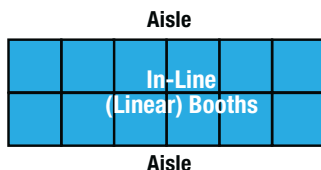

In-Line (Linear) Booth

Definition: In-Line booths have only one side exposed to an aisle and have at least one adjacent neighbor on either side of the booth.

A Corner Booth is an In-Line Booth exposed to aisles on two or three sides. The same rules for In-Lines apply for Corner Booths.

Booths are most commonly 10' wide by 10' deep. No booth construction or signage may exceed 8' in overall height. The maximum height of 8' is permitted on the back 5' section and a maximum height of 4' is permitted on the front 5' section. Please reference the diagram of allowable configurations. No hanging signage from the ceiling is allowed in an In-Line Booth.

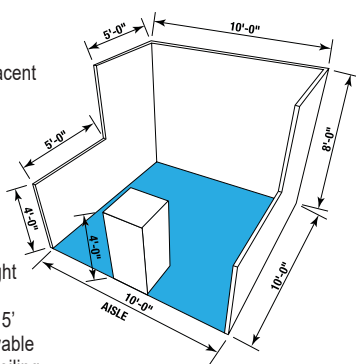

**In-Line (Linear) Booth
(Booths 10' x 10')**

Note: When three or more In-Line Booths are used as a single booth space, the 4' height limitation is applied only to that portion of booth space which is within 10' of an adjoining booth.

Perimeter In-Line Booth

Definition: A Perimeter Booth is an In-Line Booth that is the outermost aisle of booths that do not back up to another booth.

All guidelines for In-Line (Linear) Booths apply to Perimeter Booths except that the maximum backwall height allowed on the back 5' section is 12'. No hanging signage from ceiling is allowed in a Perimeter Booth. Please reference the drawing for a diagram of the allowable configurations.

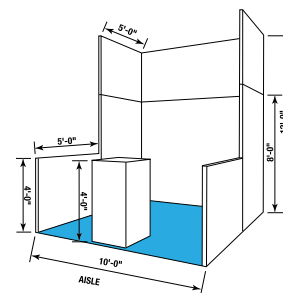

**Perimeter In-Line Booth
(Booths 10' x 10')**

Island Booths

Definition: An Island Booth is any size booth exposed to aisles on all four sides of the booth with no adjacent neighbors.

Booth fixtures, components and signage will be permitted up to a maximum height of 20'.* Hanging signs from the ceiling are permitted in Island booths that are 400 square feet and larger, but the top of the sign may not exceed 20' in overall height.

***PLEASE NOTE:** Booths on Level 1 of Javits Center cannot exceed a maximum height of 18'. (Booths on Level 3 of Javits Center are permitted the standard maximum height of 20'.)

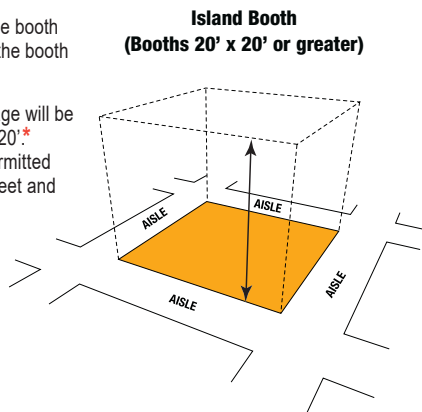

**Island Booth
(Booths 20' x 20' or greater)**

Canopies and Ceilings

Canopies, including ceilings, umbrellas and canopy frames, can be either decorative or functional (such as to shade computer monitors from ambient light or for hanging products). Canopies for In-Line (Linear) or Perimeter Booths should comply with line of sight requirements.

The base of the Canopy should not be lower than 8' from the floor within 5' of any aisle. Canopy supports should be no wider than 3". This applies to any booth configuration that has a sightline restriction, such as an In-Line (Linear) Booth. Fire and safety regulations in many facilities strictly govern the use of canopies, ceilings and other similar coverings.

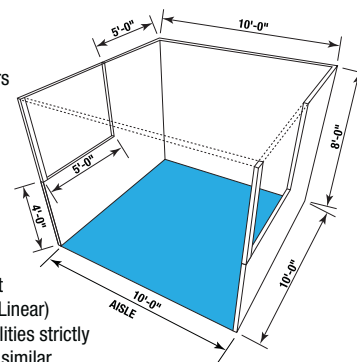

**In-Line (Linear) Booth
with Canopies or Ceilings**

Unfinished Walls

Any unfinished walls are subject to review by Show Management. Should Show Management deem the backside of the booth "unsightly" and/or does not conform to the overall quality of the show, the exhibitor may be required to drape the backside of the booth at the exhibitor's expense.

Hanging Signs

Hanging signs will be permitted in Island Booths ONLY (minimum of 400 sq. ft.) at a 20' maximum from floor to top of sign.

Signs may be hung from the ceiling (where permitted), trusswork or equipment. Signs that will be hung from the ceiling or trusswork must be installed and dismantled by the Rigging Crew. For questions on hanging signs, please call Show Management at 972-536-6337.

NOTE: If your booth design/display does not meet booth specifications, please call Show Management at 972-536-6337 or email tiffany.roe@informa.com.